

STEEL METEOROLOGICAL TOWERS

FOR:

- WIND ENERGY MONITORING
- SITE EVALUATION
- ENVIRONMENTAL STUDIES
- NUCLEAR & FOSSIL POWER PLANTS
- AGROMETEOROLOGY
- AIRPORTS
- Etc.

A COMPLETE LINE OF METEOROLOGICAL STATIONS IS ALSO OFFERED BY GEONICA FOR ENVIRONMENTAL MONITORING, including:

- Remote Data Acquisition Units
- Meteorological Sensors
- Data Transmission via GSM / GPRS, INTERNET, RADIO and SATELLITE
- DATA PROCESSING SOFTWARE

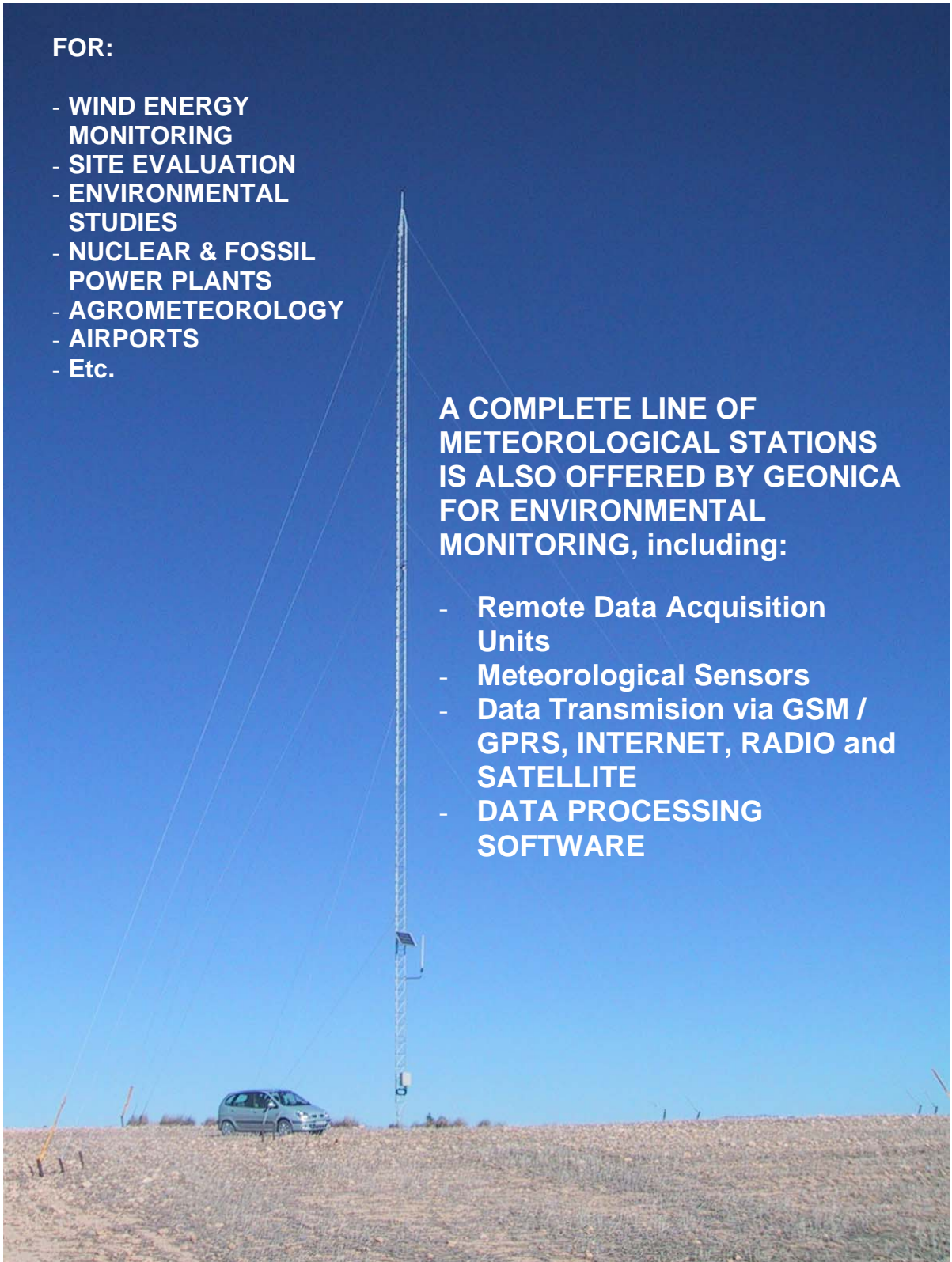

GEONICA, S.A.
EARTH SCIENCES

SINCE
1974

Alejandro Rodríguez, 22-24 28039 Madrid - Spain
Tel.: +34 91 450 51 18 Fax: +34 91 459 46 14

web: www.geonica.com
e-mail: info@geonica.com

Brochure N. 9758.0003

STEEL METEOROLOGICAL TOWERS

MODELS 180 – 360 – 450 - 600

Each tower consists on:

- One embedded fixed base, with or without pivot bearing support
- Lower 3m section
- A number of 3 m stacked intermediate sections
- One upper 3 m section
- One axial 3 m mast on top, for mounting the upper wind sensor (anemometer and wind vane or other sensor or device)

The towers are secured by several groups of wind-bracings at 120°, according to the height requirements. Instructions for mounting are indicated in the correspondent manual.

For corrosion avoidance of the steel tower, an advanced surface treatment is carried out (Zinc plating process plus reactive sealing), RPR process, offering also the best performance against scratching.

The general specifications are indicated in the next page.

STEEL TOWERS – PRODUCT RANGE

Ref.	Description
3014	M180SE Upper section 1.25m
3015	M180SE Upper section with wire ring 2.5m
3017	M180SE Lower section 2.5m
3018	M180SE Upper section 2,5m
3022	M180 Middle section 3m
3023	M180 Upper section 1m
3051	M180 Upper section 3m
3052	M180 Lower section for pivot bearing support 3m
3053	M360 Upper section 3m
3054	M360 Lower section for pivot bearing support 3m
3055	M360 Middle section 3m
3061	M180 Rotator section
3062	M360 Rotator section
3080	M180 Lower section 3m - red
3081	M180 Middle section 3m - red
3082	M180 Middle section 3m - white
3083	M180 Upper section 3m - red
3090	M360 Lower section 3m - red
3091	M360 Middle section 3m - red
3092	M360 Middle section 3m - white
3093	M360 Upper section 3m - red
3094	TW360 Lower section, 3m, stainless steel
3095	TW360 Middle section 3m, stainless steel
3096	TW360 Upper section, 3m, stainless steel
3101	M600 Standard section, 3m, white colour
3102	M600 Standard section, 3m, red colour
3103	M600 Guy wire section , 3m, white colour
3104	M600 Guy wire section , 3m, red colour
3120	M450 Base section , 3m, red
3121	M450 Middle section , 3m, white
3122	M450 Middle section , red , 3m
3123	M450 Upper section , red , 3m



GENERAL SPECIFICATIONS							
Model		180S.E.	180	360	TW360	M450	M600
Main steel tubes	(mm)	20x1.5	20x2	30x2	30x1.5(s.steel)	38x2.6	70x4
Diameter of steel transversal rods	(mm)	6	6	10	10(s.steel)	12	20
Maximum height with mast (3m)	(m)	7.5	20.5	50.5	50.5	66	83

MODELS

180			360			600		
3022	3051	3052	3023	3053	3054	3055	3101	3104
							3102	3103
INT.	UPPER	LOWER		INT.	LOWER	UPPER	INT.	WIND-BRACING
SECTIONS								

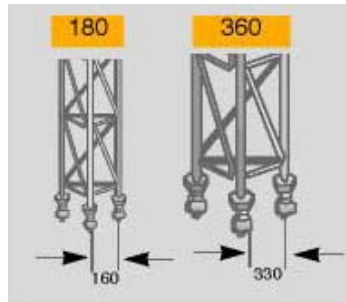

MODELS 180 / 360 DIMENSIONS

TOWER ACCESSORIES

Ref.	Description	Ref.	Description
2136	Turnbuckles (tensioner) 3/8	3057	M360 Embedded fixed base (glavanised)
3019	M180SE Embedded fixed base	3058	M360 Guy wire ring embedded
3020	M180SE Embedded fixed base	3059	Lashing wire 5mm/100m coil
3025	M180 Pivot bearing support	3098	TW360 Upper section, 3m, stainless steel
3026	M180 Embedded fixed base	3105	M600 Upper section for mast
3030	M180 Guy wire ring embedded	3106	M600 Pivot bearing support
3033	Turnbuckles (tensioner) 5/16	3107	M600 Guy wire base
3034	Lashing wire 4mm/100m coil	3108	M600 Tower base bracketry
3035	Earthing wire clamp	3109	M600 Guy wire bracketry
3039	M180 Embedded fixed base	3124	M450 Pivot bearing embedded base
3047	Embedded hooked bolt	3125	M450 Guy wire ring embedded
3056	M360 Pivot bearing embedded base	3126	M450 Embedded fixed base

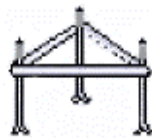

Ref. 3019

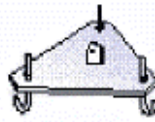

Ref. 3025

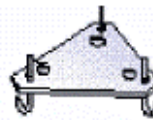

Ref. 3026



Ref. 3039

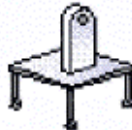

Ref. 3056

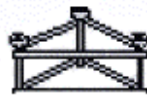

Ref. 3057



Ref. 3044



Ref. 3047



Ref. 3030



Ref. 3058



Ref. 3035



GEONICA, S.A.
EARTH SCIENCES

SINCE
1974

Alejandro Rodríguez, 22-24 28039 Madrid - Spain
Tel.: +34 91 450 51 18 Fax: +34 91 459 46 14

web: www.geonica.com
e-mail: info@geonica.com